

[Buyer's Guide]

Z-6010

Compact Omnidirectional Laser Scanner

Standard Device

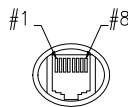
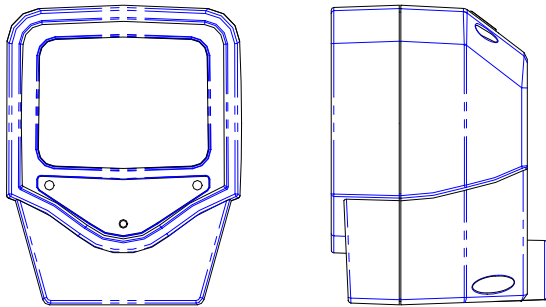

PIN-OUT CONFIGURATION		
Pin	Function	
	Keyboard	RS-232C
1	DC + 5V input	
2	Keyboard Clock	N.C.
3	PC Clock	RTS_TTL
4	Ground	
5	N.C.	TXD_TTL
6	N.C.	RXD_TTL
7	Keyboard Data	N.C.
8	PC Data	CTS_TTL

Standard Accessory – Fixed Stand

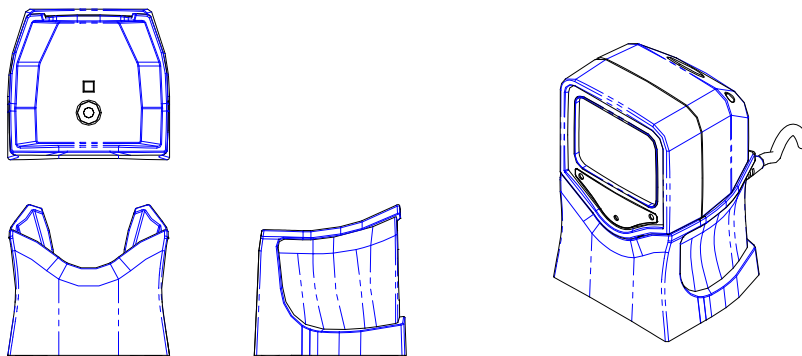

Barcode	Model	Part No.	Remark
	Fixed Stand	886-10HL00-001	IBM Black Color

Optional Accessory – Adjustable Stand

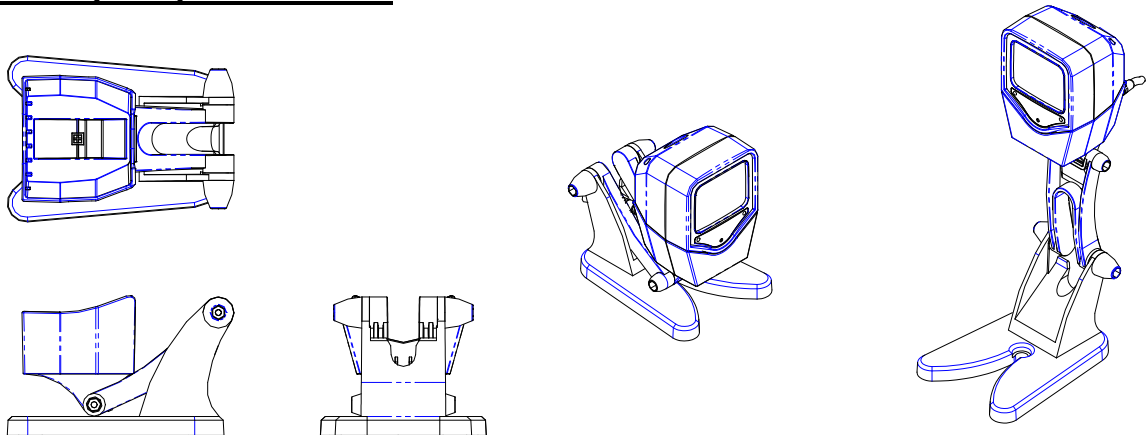

















Barcode	Model	Part No.	Remark
	Adjustable Stand	886-10AH00-001	IBM Black Color

[Buyer's Guide]

Ordering Information

(Fixed stand included for standard package)



Barcode	P/N	Model Name	Remark
	886-100000-000	Z-6010	White Housing w/Fixed Stand w/o Cable
	886-100000-001	Z-6010 (B)	Black Housing w/Fixed Stand w/o Cable
	886-1000KP-000	Z-6010(K)	White Housing w/PS/2 Cable w/Fixed Stand
	886-1000KP-001	Z-6010(K)(B)	Black Housing w/PS/2 Cable w/Fixed Stand
	886-1000RP-000	Z-6010(R)	White Housing w/RS-232 Cable (DTE Pin-out) w/Fixed Stand
	886-1000RP-001	Z-6010(R)(B)	Black Housing w/RS-232 Cable (DTE Pin-out) w/Fixed Stand
	886-1000UB-000	Z-6010 (U)	White Housing w/USB Cable w/Fixed Stand
	886-1000UB-001	Z-6010(U)(B)	Black Housing w/USB Cable w/Fixed Stand
	886-100000-0NB	Z-6010	White Housing w/o Cable w/Fixed Stand w/Neutral Gray Logo w/o Cable
	886-100000-0N1	Z-6010 (B)	Black Housing w/o Cable w/Fixed Stand w/Neutral Gray Logo w/o Cable
	886-1000KP-0NB	Z-6010(K)	White Housing w/PS/2 Cable w/Fixed Stand w/Neutral Gray Logo
	886-1000KP-0N1	Z-6010(K)(B)	Black Housing w/PS/2 Cable w/Fixed Stand w/Neutral Gray Logo
	886-1000RP-0NB	Z-6010(R)	White Housing w/RS-232 Cable (DTE Pin-out) w/Fixed Stand w/Neutral Gray Logo
	886-1000RP-0N1	Z-6010(R)(B)	Black Housing w/RS-232 Cable (DTE Pin-out) w/Fixed Stand w/Neutral Gray Logo
	886-1000UB-0NB	Z-6010 (U)	White Housing w/USB Cable w/Fixed Stand w/Neutral Gray Logo
	886-1000UB-0N1	Z-6010(U)(B)	Black Housing w/USB Cable w/Fixed Stand w/Neutral Gray Logo

[Buyer's Guide]

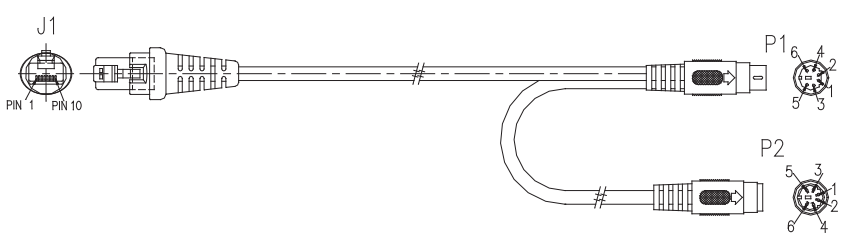

Cable Options

- The standard cable is gray, straight, and 2 meters (6.5 feet) in length.
- The standard cable options include PS/2, RS-232, or USB.
- Special Order Requirement:
ZEBEX is capable of supplying special customized cable, given that customers provide detailed pin configurations. The minimum order quantity of a special cable is 250 pcs.

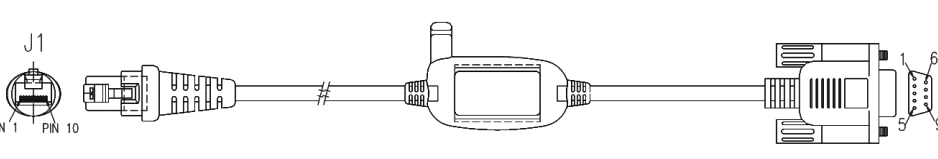

Keyboard Wedge Cable (for PS/2)

		MINI DIN (M)		MINI DIN(F)	
		DIN	FUNCTION	DIN	FUNCTION
		1.	PC Data	1.	KB Data
		2.	N.C.	2.	N.C.
		3.	GND	3.	GND
		4.	+5V	4.	+5V
		5.	PC Clock	5.	KB Clock
		6.	N.C.	6.	N.C.
Item Part No.	171-42K100-200				

1. RS-232C Cable (DTE Pin-out)

		DB-9 (F)	FUNCTION
		2	TX
		3	RX
		7	CTS
		8	RTS
		5	GND
		9	+5V
Item Part No.	171-42R442-200		

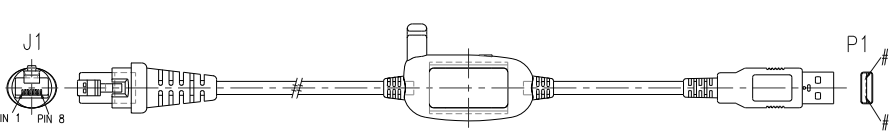
2. USB Cable

		USB TYPE A CONNECTOR	FUNCTION
		1.	VCC
		2.	D-
		3.	D+
		4.	VSS
HID USB / OPOS USB	Item Part No.	171-40U322-200	
USB Virtual COM(w/o DC Jack) (non-standard option)	Item Part No.	171-40U310-200	

* Additional software or special firmware may be necessary for activating virtual COM or OPOS USB interface.

[Buyer's Guide]

Power Adapter

Z-6010 requires a minimum of 200mA at 5 VDC power and consumes power from the host machine. If the host can not supply sufficient power, ZEBEX provides adapters of the following plug types:

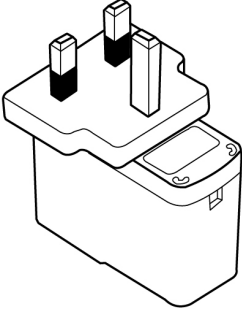
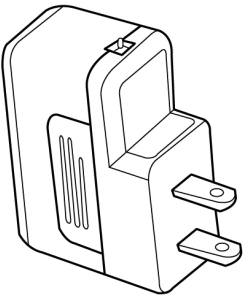
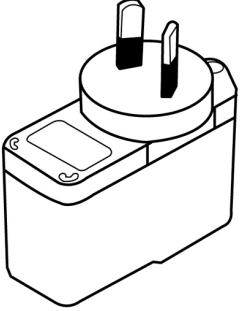
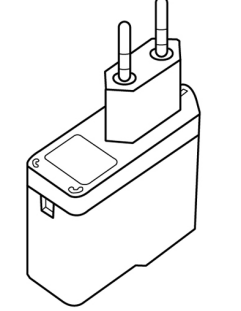
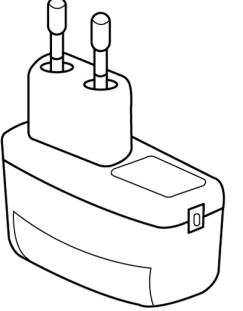
UK Plug	US Plug	Australian Plug	European Plug	Korean Plug
				

* The figures are for reference only. The adaptor form factor is subject to change without prior notice.